

MULTI-UNIT CHARGER KITS

PMPN4283
PMPN4286
PMPN4288
PMPN4370
PMPN4380

USER GUIDE

en-US



MOTOROLA SOLUTIONS

TABLE OF CONTENTS

Important Safety Instructions	3
Operational Safety Guidelines	4
Supported Models.....	5
Charger, Pocket, and Communications Interface	10
Charger Overview.....	11
IMPRES 2 and IMPRES Batteries and Chargers	12
Features and Benefits.....	12
IMPRES Battery Initialization	13
Automatic IMPRES Battery Calibration/Reconditioning	13
Manually Initiating Calibration/Reconditioning	13
Manually Terminating Calibration/Reconditioning.....	14
End-of-Service-Life Indication	14
Charging Procedure.....	15
Display Messages and LED Indications.....	17
IMPRES Battery Long-Term Storage.....	24
Lithium-Ion Battery Preparation for Shipment.....	27
Charger Setup	31
Main Menu	32
Charger Setup Menu Selection.....	33
Ship/Storage Menu	34
Calibration Menu.....	35
End-of-Service Life Indication Menu	36
Display Format Menu.....	37
Capacity Format Menu.....	38
Power Saver Menu.....	39
Entry Time Menu.....	40
Language Menu	41
Analyzer Mode	41
IMPRES 2 Battery.....	42
IMPRES Battery.....	43
Other Motorola Solutions Battery.....	44
Unknown Battery.....	45
Empty Pocket.....	45
Charger Reprogramming	45
Charger Troubleshooting	46

IMPRES Battery Fleet Management System.....	48
Charging Pocket Installation	52
Removing Charging Pocket from Multi-Unit Charger	52
Securing Charging Pocket to Multi-Unit Charger	53
Programming a Radio with iTM Proxy (PMPN4286_).....	55
Optional Equipment	56
Mounting Multi-Unit Charger to Wall Bracket.....	57

Note: The term *radio* used throughout this manual also refers to the pager and other radio communication devices.

Important Safety Instructions

This document contains important safety and operating instructions. Please read these instructions carefully and save them for future reference.

Before using the battery charger, read all the instructions and cautionary markings on (1) the charger, (2) the battery, and (3) the radio using the battery.



1. To reduce risk of damage to the power supply electric plugs and cords, pull the plug rather than the cord when disconnecting from the AC outlet or the charger.
2. An extension cord should not be used unless absolutely necessary. Use of an improper extension cord could result in risk of fire and electric shock. If an extension cord must be used, make sure that the cord size is 18 AWG for lengths of up to 6.5 feet (2.0 m), and 16 AWG for lengths up to 9.8 feet (3.0 m).
3. To reduce risk of fire, electric shock, or injury, do not operate the charger if it has been broken or damaged in any way. Take it to a qualified Motorola Solutions service representative.
4. Do not disassemble the charger. It is not repairable and replacement parts are not available. Disassembly of the charger may result in risk of electric shock or fire.
5. To reduce risk of electric shock, unplug the charger power supply from the AC outlet before attempting any maintenance or cleaning.
6. To reduce risk of injury, charge only the rechargeable Motorola Solutions Authorized Batteries listed in Table 5. Other batteries may explode, causing personal injury and damage.
7. Use of accessories not recommended by Motorola Solutions may result in risk of fire, electric shock, or injury.

Operational Safety Guidelines

- This equipment is not suitable for outdoor use. Use only in dry locations and conditions.
- Maximum ambient temperature around the charger must not exceed 40 °C (104 °F).
- The radio can be in ON only when the radio is transmitting data wirelessly, such as using Wi-Fi. Otherwise, turn OFF the radio.
- Connect the charger to the power supply listed in Table 3 with an appropriate power cord listed in Table 4.
- The AC outlet to which the power supply is connected should be close and easily accessible.
- Make sure the power supply cord to the charger is located where it will not be stepped on, tripped over, or subjected to water, damage, or stress.
- Connect the power cord only to an appropriately fused and wired AC outlet with the correct voltage, as specified on the product.
- Disconnect from line voltage by removing the power cord from the AC outlet.
- Multi-Unit Chargers will charge the batteries listed in Table 5, when used with Pockets in Table 2. The batteries may be attached to a radio or may be stand-alone.

Supported Models

Table 1: Multi-Unit Charger

Kit Number	Description	Type	Display	Charging Pockets	Communication Interface	
PMPN4283_	MOTOTRBO Professional Digital Radios Series IMPRES™ Multi-Unit Charger	IMPRES 2™	1-Display		Charger Reprogramming and Fleet Management	
PMPN4286_	TPG2200 IMPRES Multi-Unit Charger				Six Devices and/or Batteries	Charger Reprogramming and Fleet Management and iTM Programming
PMPN4288_	GP and HT Professional Series IMPRES Multi-Unit Charger					Charger Reprogramming and Fleet Management
PMPN4370_	ST Series IMPRES Battery-Only Multi-Unit Charger			Six Batteries	Charger Reprogramming and Fleet Management	
PMPN4380_	Si500/700 Series IMPRES Multi-Unit Charger			Six Devices and/or Batteries	Charger Reprogramming and Fleet Management	

Table 2: Multi-Unit Charger Pockets
(compatible with charger(s) in Table 1)

Multi Unit Charger	Pocket	Description
PMPN4370_	AS000111A01	Tri-Unit Charger Pocket for Battery Only
PMPN4283_	HW001384A01	Tri-Unit Charger Pocket for Radio and Battery
PMPN4288_	HW001385A01	
PMPN4286_	HW001386A01	Tri-Unit Charger Pocket for Radio and Battery, with iTM Programming
PMPN4380_	AS000063A01	Tri-Unit Charger Pocket for Radio and Battery

Table 3: Motorola Solutions Authorized Power Supply

Part Number	Description
PS000242A01	External 90 W Power Supply

Table 4: Motorola Solutions Authorized Power Cords

Part Number	Description
3087791G01	Power Cord, United States/North America
3087791G04	Power Cord, Europe
3087791G07	Power Cord, United Kingdom/Hong Kong
3087791G10	Power Cord, Australia/New Zealand
3087791G13	Power Cord, Argentina
3087791G16	Power Cord, Korea
3087791G20	Power Cord, Japan
3087791G22	Power Cord, Brazil
CB000199A01	Power Cord, China

Table 5: Motorola Solutions Authorized Batteries

Multi-Unit charger	Part Number	Description
PMPN4283_	NNTN7789_	IMPRES IECEX IP67 Li-Ion Battery
	NNTN8128_	IMPRES Li-Ion Battery
	NNTN8129_	High-Capacity IMPRES IP67 Li-Ion FM Battery
	NNTN8287_	IMPRES CSA 157 IP67 Li-Ion Battery
	NNTN8305_	IMPRES Li-Ion Battery
	NNTN8359_	IMPRES IECEX/ATEX IP67 Li-Ion Battery
	NNTN8386_	IMPRES CSA 157 Li-Ion Battery
	NNTN8560_	IMPRES IP67 TIA4950 Li-Ion Battery
	NNTN8570_	IMPRES IECEX/ATEX IP67 Li-Ion Battery
	NNTN8750_	IMPRES CSA IP67 Li-Ion Battery
	NNTN8840_	IMPRES IECEX IP67 Li-Ion Battery
	PMNN4065_	Ni-MH Battery
	PMNN4066_	IMPRES Li-Ion Battery
	PMNN4069_	IMPRES Li-Ion FM Battery
	PMNN4077_	High-Capacity IMPRES Li-Ion Battery
	PMNN4101_	IMPRES IP57 Li-Ion Battery
	PMNN4102_	IMPRES IP57 Li-Ion FM Battery
	PMNN4103_	High-Capacity IMPRES IP57 Li-Ion Battery
	PMNN4104_	IP57 Ni-MH Battery
	PMNN4262_	Ultra High-Capacity IMPRES IP57 Li-Ion Battery
	PMNN4406_	IP68 Li-Ion Battery
	PMNN4407_	IMPRES IP68 Li-Ion Battery
	PMNN4409_	High-Capacity IMPRES IP68 Li-Ion Battery
	PMNN4412_	IP58 Ni-MH Battery
	PMNN4415_	IP56 Ni-MH Battery
	PMNN4416_	IP56 Li-Ion Battery
	PMNN4417_	IMPRES IP56 Li-Ion Battery
	PMNN4418_	High-Capacity IMPRES IP56 Li-Ion Battery
PMNN4424_	High-Capacity IMPRES Li-Ion Battery	

Table 5: Motorola Solutions Authorized Batteries (Cont.)

English

Multi-Unit charger	Part Number	Description
PMPN4283_	PMNN4435_	IP68 Li-Ion Battery
	PMNN4448_	High-Capacity IMPRES IP67 Li-Ion Battery
	PMNN4463_	IP68 Li-Ion Battery
	PMNN4488_	IMPRES IP68 HE DENS Li-Ion Battery for Vibrating Belt Clip
	PMNN4489_	IMPRES IP68 TIA4950 HE DENS Li-Ion Battery
	PMNN4490_	IMPRES IP68 TIA4950 HE DENS Li-Ion Battery
	PMNN4491_	IMPRES IP68 Li-Ion Battery
	PMNN4493_	IMPRES IP68 HE DENS Li-Ion Battery
	PMNN4525_	IMPRES IP68 Li-Ion Battery
	PMNN4543_	IP68 Li-Ion Battery
	PMNN4544_	High-Capacity IMPRES IP68 Li-Ion Battery
PMPN4286_	PMNN4510_	IMPRES 2 Li-Ion Battery
PMPN4288_	HNN4001_	IMPRES Ni-MH Battery
	HNN4002_	IMPRES Ni-MH FM Battery
	HNN4003_	IMPRES Li-Ion Battery
	HNN9008_	High-Capacity Ni-MH Battery
	HNN9009_	Ultra High-Capacity Ni-MH Battery
	HNN9010_	Ni-MH FM Battery
	HNN9013_	Li-Ion Battery
	JMNN4023_	Li-Ion Battery
	JMNN4024_	High-Capacity Li-Ion Battery
	JMNN4025_	Ni-MH FM Battery
	NNTN4503_	Ni-MH Battery
	NNTN5510_	Li-Ion ATEX Battery
	NNTN7380_	Ni-MH MSHA Battery
	NNTN7383_	Li-Ion ATEX Battery
	PMNN4045_	Mag One Ni-MH Battery
	PMNN4073_	IP67 Li-Ion FM Battery

Table 5: Motorola Solutions Authorized Batteries (Cont.)

Multi-Unit charger	Part Number	Description
PMPN4288_	PMNN4074_	IP67 Li-Ion Battery
	PMNN4094_	IP67 Li-Ion Battery
	PMNN4097_	High-Capacity Ni-MH Battery with Belt Clip
	PMNN4151_	Ni-MH Battery
	PMNN4154_	High-Capacity Ni-MH Battery
	PMNN4156_	IMPRES Ni-MH Battery
	PMNN4157_	IMPRES Ni-MH FM Battery
	PMNN4158_	Li-Ion Battery
	PMNN4159_	High-Capacity IMPRES Li-Ion Battery
	PMNN4201_	Li-Ion Battery
	PMNN4202_	High-Capacity Li-Ion Battery
	PMNN4257_	High-Capacity Mag One Li-Ion Battery
	PMNN4401_	Li-Ion CEPEL Battery
	PMNN4440_	IP67 Li-Ion Battery
	PMNN4455_	High-Capacity Li-Ion Battery
	PMNN4457_	Mag One Li-Ion Battery
	PMNN4502_	High-Capacity IMPRES IP67 Li-Ion Battery
	PMNN4511_	High-Capacity IMPRES IP67 TIA4950 Li-Ion Battery
PMPN4370_	PMNN4510_	IMPRES 2 Li-Ion Battery
PMPN4380_	PMNN4507_	Li-Ion Battery
	PMNN4508_	Li-Ion Battery
	PMNN4530_	IMPRES 2 Li-Ion Battery
	PMNN4549_	IMPRES 2 Li-Ion Battery

Charger, Pocket, and Communications Interface

The Standard Multi-Unit Charger System charges a wide variety of battery types for Motorola Solutions batteries. It has pockets that accommodate either a radio with attached battery or a stand-alone battery.

The IMPRES 2 Adaptive Charger System is a fully automated IMPRES 2 battery care system that is equipped with additional features:

- Adaptive charging to accommodate a wide variety of battery types, including IMPRES 2, IMPRES, and other authentic Motorola Solutions batteries.
- Communications Interface
 - Charger reprogramming.
 - IMPRES battery data upload to an IMPRES Battery Fleet Management System.
 - iTM communication through USB hub.
- Keypad Menu
 - Charger Setup.
 - Battery Analysis.
- Information Display on Pocket 1.
- Energy Efficiency Features – the charger pockets will automatically sleep, then wake to respond to user activities, or to service a battery in the pocket.
- Preparation of a battery for long-term storage.
- Preparation of a Lithium-ion battery for shipment.

There are additional advantages when charging an IMPRES 2 Lithium-ion battery with an IMPRES 2 Adaptive Charger:

- Higher-rate IMPRES 2 Lithium-ion battery charging.
- Faster charging.
- Extended life cycle.

This feature combination is unique in a desktop charger. Therefore, operation of the radio with a battery attached while in the charger is not recommended.

During the charging process, radio operation may result in minimally reduced radio performance and extended battery charge time.

During Calibration/Reconditioning, the battery is fully discharged before being fully charged. As a result, the radio may shut down during the discharge phase.

Charger Overview

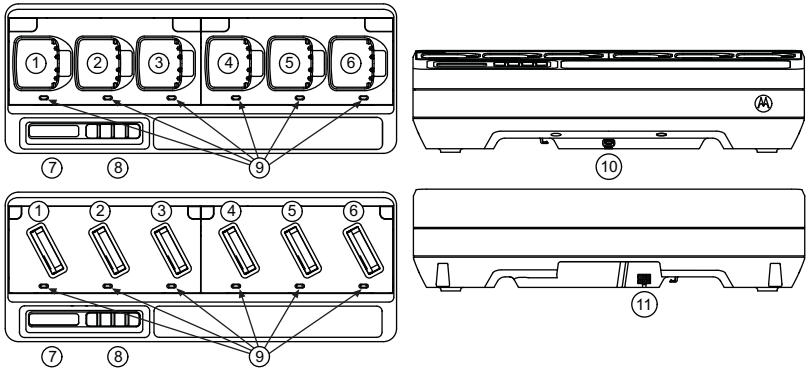

Figure 1: Charger Overview

Table 6: Charger Overview and Description

Number	Description
1–6	Charging Pockets – To charge batteries attached to a radio or stand-alone.
7	Display – For Pocket 1 only. Displays the available menu selections.
8	Keypad – For menu selection.
9	LED Status Indicator – Indicates the charging status of the battery.
10	Communications Interface – Supports charger reprogramming and data upload to an IMPRES Battery Fleet Management System and iTM communication through USB port. Refer to Table 2 for the selected Multi-Unit Charger pockets that support iTM Communication.
11	Power Connector Inlet – Compatible with Power Supply in Table 3.

IMPRES 2 and IMPRES Batteries and Chargers

Features and Benefits

The IMPRES energy solution is an advanced Tri-Chemistry energy system developed by Motorola Solutions. This system includes:

1. IMPRES Batteries
2. IMPRES Adaptive Charger
3. IMPRES Radios

Charging IMPRES batteries using an IMPRES Adaptive Charger, with the charger periodically Calibrating/Reconditioning the battery, yields the following benefits:

- Extends battery life cycle.
- Measures battery capacity, giving the radio user an indication of effective use time.
- Determines the current battery state of charge, giving the radio user an indication of effective use time.
- Monitors the IMPRES battery usage pattern.
- Updates pattern information stored in the IMPRES battery.
- Automatically performs Calibration/Reconditioning only as needed.
- Minimizes IMPRES battery heating, regardless of how long the battery is left in the pocket.
- Periodically “tops off” a battery stored in the charger pocket, maintaining a high state of readiness for the user.
- Eliminates Nickel battery memory effect, eliminating the need to purchase special equipment or train personnel in tasks to maintain battery life cycle.

Using this unique patented system, there is no need to track and record IMPRES battery use, conduct manual Calibration/Reconditioning, or remove batteries from chargers following completion of charge.

IMPRES Battery Initialization

For full IMPRES functionality, a new IMPRES battery or IMPRES 2 battery must be initialized by the charger. The charger automatically detects the new IMPRES or IMPRES 2 battery, and automatically starts Initialization. Initialization is the first IMPRES battery Calibration/Reconditioning. This is a two-phase process. The first phase is Battery Discharge, indicated by the Status LED in **Steady Amber**. The second phase is full charge, eventually indicated by **Steady Green** LED. This process may take up to 12 hours or more to complete, depending on the state of charge and capacity of the battery. Interruption of either phase delays Initialization until the next charging opportunity.

Automatic IMPRES Battery Calibration/Reconditioning

The IMPRES 2 charger automatically assesses the condition of an IMPRES or IMPRES 2 battery. Based on this condition, the charger automatically calibrates/reconditions the battery. Interruption of either the discharge phase or the full charge phase delays Calibration until the next charging opportunity. Calibration/Reconditioning may be enabled or disabled using Charger Setup Mode. When disabled and the IMPRES battery requires Calibration/Reconditioning, the LED indicates **Alternating Amber/Green** at battery insertion and after the battery is charged.

Manually Initiating Calibration/Reconditioning

Though Calibration/Reconditioning is automatic, there may be situations in which manual initiation is desired. To manually initiate Calibration/Reconditioning, remove IMPRES or IMPRES 2 battery from the charger. Then, perform the following steps:

1. Insert the battery into the charger pocket.
2. Within 2.5 minutes, remove the battery from the charger pocket.
3. Within five seconds, reinsert the battery into the charger pocket.

Calibration/Reconditioning starts immediately, typically beginning with Battery Discharge (**Steady Amber**). Calibration/Reconditioning is complete only after full charge (**Steady Green**).

Manually Terminating Calibration/Reconditioning

At any time during IMPRES or IMPRES 2 battery discharge (**Steady Amber**), Calibration/Reconditioning may be terminated. Perform the following steps:

1. Remove the battery from the charger pocket.
2. Within five seconds, reinsert the battery into the charger pocket.

Battery discharge immediately terminates, and Normal battery charging starts. The LED indicates Charge Status.

End-of-Service-Life Indication

As batteries are used, normal wear reduces available capacity. At the successful completion of Calibration/Reconditioning, IMPRES chargers compare IMPRES battery capacity to the battery Rated Capacity. When the capacity is at a very low value, the IMPRES battery may be nearing its End of Service. The IMPRES battery remains usable. In some scenarios, it may be desirable to deploy the battery to someone who does not require large battery capacity to complete a work shift.

Charging Procedure

Batteries charge best at room temperature. Batteries to be attached to a radio or stand-alone.

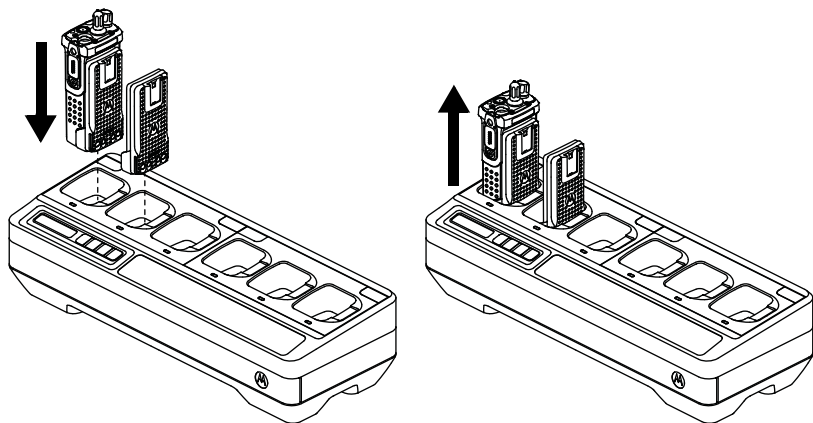

Figure 2: PMPN4283_/PMPN4286_/PMPN4288_ Charging Procedure

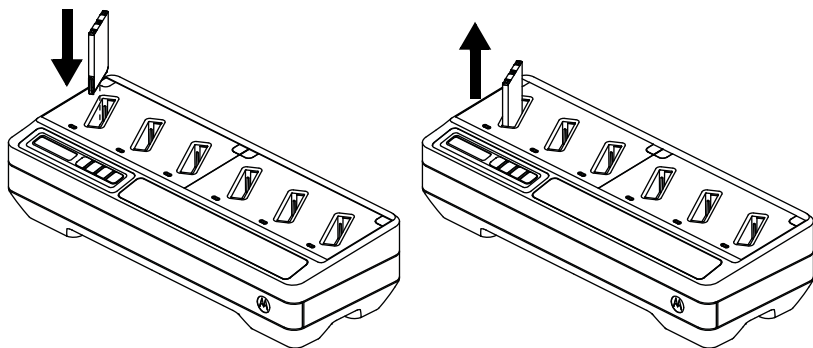

Figure 3: PMPN4370_ Charging Procedure

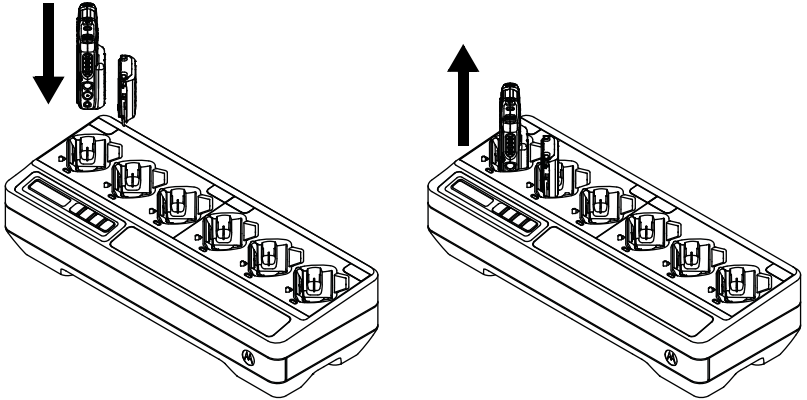

Figure 4: PMPN4380_ Charging Procedure

1. Place the Multi-Unit Charger (MUC) on a flat surface.
2. Firmly insert the power supply into the charger DC Inlet Socket at the back of the charger.
3. Plug the power supply power cord into a matching power outlet.
4. Upon successful power-up, each pocket LED shows **Green** for one second and **IMPRES 2 CHARGER** is displayed. If the LEDs do not flash and no message is displayed, check power cord connections.
5. Insert the radio with battery or stand-alone battery into an available pocket.
6. When the radio or stand-alone battery is properly seated in the pocket:
 - Charging status of a radio is indicated by the LED Status Indicator and/or display of the radio.
 - Charging status of a stand-alone battery is indicated by the LED Status Indicator of the associated pocket on the MUC.
 - The Display of the MUC shows the charging status of Pocket 1 only.
7. The radio or stand-alone battery is ready for use when the LED is **Steady Green**.
8. Only turn on the radio while in iTM Communication mode. Otherwise, turn off the radio.

Note: Grip the radio body when inserting, or removing the radio from the charger. Avoid pulling the radio antenna when removing the radio.

Display Messages and LED Indications

Messages and LED indications are associated with charger software version 1.05.

IMPRES 2 Battery or IMPRES Battery

Charging an IMPRES 2 or IMPRES battery uses the display messages and LED indications summarized in Table 7 and Table 9.

Table 7: Charging IMPRES 2 or IMPRES Batteries - Calibration Not Required







Status	Pocket Display	LED Indicator	
Charger Powers On	IMPRES 2 CHARGER	Green for approximately one second	
Battery Detected	IMPRES 2 BATTERY or IMPRES BATTERY	Steady Red	
Rapid Charging	RAPID CHARGE XXXX@mAh yy% %	Steady Red	
Charged to 90% or more	TRICKLE CHARGE xxxx@mAh yy% %	Flashing Green	
Charged to 95% or more	CHARGE COMPLETE xxxx@mAh yy% %	Steady Green	
Fault	Warning: NOT CHARGEABLE REMOVE& REINSERT	Flashing Red	

Table 7: Charging IMPRES 2 or IMPRES Batteries - Calibration Not Required (Cont.)

Status	Pocket Display	LED Indicator
Standby (Battery is waiting to rapid charge)	Warning: HOT BATTERY WAITING TO CHARGE or COLD BATTERY WAITING TO CHARGE or VERY LOW BATTERY WAITING TO CHARGE	Flashing Amber 

Table 8: Charging IMPRES 2 or IMPRES Batteries - Calibration Required, but Not Enabled









Status	Charger Display	LED Indicator
Charger Powers On	IMPRES 2 CHARGER	Green for approximately one second 
Battery Detected	IMPRES 2 BATTERY or IMPRES BATTERY	Battery requires Calibration, but Calibration is disabled in charger: Alternating Amber/ Green for four seconds 
Requesting IMPRES Battery Calibration • Calibration is disabled in charger. • Charging Battery until OK is selected or time-out.	Warning: ENABLE BATTERY CALIBRATION? • Press OK to enable Calibration. • Ignore for normal charging (message disappears after one minute).	Steady Red 
Rapid Charging (Request for Calibration time-out)	RAPID CHARGE	Steady Red 
Charged to 90% or more	TRICKLE CHARGE	Flashing Green 

Table 8: Charging IMPRES 2 or IMPRES Batteries - Calibration Required, but Not Enabled (Cont.)

Status	Charger Display	LED Indicator
Charged to 95% or more	CHARGE COMPLETE	Battery requires Calibration, but Calibration is disabled in charger: Alternating Amber/ Green 
Fault	Warning: NOT CHARGEABLE REMOVE& REINSERT	Flashing Red 
Standby (Battery is waiting to rapid charge)	Warning: HOT BATTERY WAITING TO CAL or COLD BATTERY WAITING TO CAL or VERY LOW BATTERY WAITING TO CHARGE	Flashing Amber 

Calibrating/Reconditioning an IMPRES 2 or IMPRES battery uses the display messages and LED indications summarized in Table 9 and Table 10.

Table 9: Calibrating/Reconditioning IMPRES 2 or IMPRES Batteries - Calibration Enabled



Status	Pocket Display	LED Indicator
Charger Powers On	IMPRES 2 CHARGER	Green for approximately one second 
Battery Detected	IMPRES 2 BATTERY or IMPRES BATTERY	Steady Amber 
Battery Discharging • Battery needs Calibration. • Battery does not need Calibration, but Calibration is initiated.	CAL DISCHARGE or CAL DISCHARGE xxxx@mAh yy% %	Steady Amber 

Table 9: Calibrating/Reconditioning IMPRES 2 or IMPRES Batteries - Calibration Enabled (Cont.)







Status	Pocket Display	LED Indicator
Rapid Charging	CAL RAPID CHARGE xxxxx@mAh yyy%	Steady Red 
Charged to 90% or more	CAL TRICKLE CHARGE xxxxx@mAh yyy%	Flashing Green 
Charged to 95% or more	CHARGE COMPLETE xxxxx@mAh yyy%	Battery Calibration successful: Steady Green  Battery Calibration successful, but may be nearing End of Service (battery is usable): Flashing Red/Green 
Fault	Warning: NOT CHARGEABLE REMOVE & REINSERT	Flashing Red 
Standby (Battery is waiting to rapid charge)	Warning: HOT BATTERY WAITING TO CAL or COLD BATTERY WAITING TO CAL or VERY LOW BATTERY WAITING TO CHARGE	Flashing Amber 

Table 10: Calibrating/Reconditioning IMPRES 2 or IMPRES Batteries - Calibration Initially Disabled, then Enabled



Status	Charger Display	LED Indicator
Charger Powers On	IMPRES 2 CHARGER	Green for approximately one second 
Battery Detected	IMPRES 2 BATTERY or IMPRES BATTERY	Battery requires Calibration, but Calibration is disabled in charger: Alternating Amber/ Green for four seconds 

Table 10: Calibrating/Reconditioning IMPRES 2 or IMPRES Batteries - Calibration Initially Disabled, then Enabled (Cont.)









Status	Charger Display	LED Indicator
Requesting IMPRES Battery Calibration <ul style="list-style-type: none"> • Calibration is disabled in charger. • Charging battery until OK is selected or time-out. 	Warning: ENABLE BATTERY CALIBRATION? <ul style="list-style-type: none"> • Press OK to enable Calibration. • Ignore for normal charging (message disappears after one minute). 	Steady Red 
Battery Discharging (OK selected)	CAL DISCHARGE	Steady Amber 
Rapid Charging	CAL RAPID CHARGE xxxxx0mAh yy% %	Steady Red 
Charged to 90% or more	CAL TRICKLE CHARGE xxxxx0mAh yy% %	Flashing Green 
Charged to 95% or more	CHARGE COMPLETE xxxxx0mAh yy% %	Battery Calibration successful: Steady Green  Battery Calibration successful, but may be nearing End of Service (battery is usable): Flashing Red/Green 
Fault	Warning: NOT CHARGEABLE REMOVE& REINSERT	Flashing Red 

Table 10: Calibrating/Reconditioning IMPRES 2 or IMPRES Batteries - Calibration Initially Disabled, then Enabled (Cont.)

Status	Charger Display	LED Indicator
Standby (Battery is waiting to rapid charge)	Before Calibration Enabled Warning: HOT BATTERY WAITING TO CHARGE or COLD BATTERY WAITING TO CHARGE	Flashing Amber 
	After Calibration Enabled Warning: HOT BATTERY WAITING TO CAL or COLD BATTERY WAITING TO CAL	
	Regardless of Calibration Enabled/Disabled: VERY LOW BATTERY WAITING TO CHARGE	

Other Motorola Solutions Batteries**Table 11: Charging Other Motorola Solutions Batteries**







Status	Charger Display	LED Indicator
Charger Powers On	IMPRES 2 CHARGER	Green for approximately one second 
Battery Detected	MOTOROLA SOLUTIONS BATTERY	Steady Red 
Rapid Charging	RAPID CHARGE	Steady Red 
Charged to 90% or more	TRICKLE CHARGE	Flashing Green 
Charged to 95% or more	CHARGE COMPLETE	Steady Green 

Table 11: Charging Other Motorola Solutions Batteries (Cont.)

Status	Charger Display	LED Indicator
Fault	Warning: NOT CHARGEABLE REMOVE & REINSERT	Flashing Red 
Standby • Battery is waiting to rapid charge. • Battery may be too hot, too cold or low voltage.	Warning: HOT BATTERY WAITING TO CHARGE or COLD BATTERY WAITING TO CHARGE or VERY LOW BATTERY WAITING TO CHARGE	Flashing Amber 

Unknown Battery

Some Unknown Batteries may not be detectable by the charger. Unknown Batteries do not declare charging parameters in a manner recognizable by the charger. If an Unknown Battery is detected, then the charger will indicate charging as summarized in Table 12.

Table 12: Charging Unknown Batteries







Status	Charger Display	LED Indicator
Charger Powers On	IMPRES 2 CHARGER	Green for approximately one second 
Battery Detected	UNKNOWN BATTERY	Steady Red 
Rapid Charging	RAPID CHARGE	Steady Red 
Nearly Charged (Battery Capacity Unknown)	TRICKLE CHARGE	Flashing Green 
Charged (Battery Capacity Unknown)	CHARGE COMPLETE	Steady Green 
Fault	Warning: NOT CHARGEABLE REMOVE & REINSERT	Flashing Red 

Table 12: Charging Unknown Batteries (Cont.)

Status	Charger Display	LED Indicator
Standby <ul style="list-style-type: none"> Battery is waiting to rapid charge. Battery may be too hot, too cold, or low voltage. 	Warning: HOT BATTERY WAITING TO CHARGE or COLD BATTERY WAITING TO CHARGE or VERY LOW BATTERY WAITING TO CHARGE	Flashing Amber 

IMPRES Battery Long-Term Storage

You can prepare authentic Motorola Solutions IMPRES 2 or IMPRES Lithium-Ion or Nickel batteries for Long-Term Storage. Selection of Long-Term Storage supersedes Calibration/Reconditioning. Lithium batteries prepared for Long-Term Storage may not meet regulations for shipment by air cargo.

Table 13: Preparing IMPRES 2 or IMPRES Batteries for Long-Term Storage - Calibration Not Required







Status	Charger Display	LED Indicator
Charger Powers On	IMPRES 2 CHARGER	Green for approximately one second 
Battery Detected	IMPRES 2 BATTERY or IMPRES BATTERY	Battery requires Discharge: Steady Amber  Battery requires Charge: Steady Red 
Battery Discharging (Discharging to selection)	STORAGE DISCHRG xx% Rated Cap	Steady Amber 
Rapid Charging (Charging to selection)	STORAGE CHARGE xx% Rated Cap	Steady Red 
Nearly Charged (Charging to selection)	STORE TRKL CHRG xx% Rated Cap	Flashing Green 

Table 13: Preparing IMPRES 2 or IMPRES Batteries for Long-Term Storage - Calibration Not Required (Cont.)





Status	Charger Display	LED Indicator
<ul style="list-style-type: none"> Discharge or Charge Complete Ready to Store 	LONGTERM STORAGE xx% Rated Cap	Battery does not require Calibration: Steady Green  Battery requires Calibration, but Calibration is disabled in charger: Alternating Amber/ Green 
Fault <ul style="list-style-type: none"> Battery Faulted No discharge current Capacity too low to complete charge 	Warning: NOT CHARGEABLE REMOVE & REINSERT or CANNOT DISCHARGE FOR LT STORAGE or STORE INCOMPLETE Low Capacity:yy%	Flashing Red 
Standby <ul style="list-style-type: none"> Battery is waiting to rapid charge. Battery may be too hot, too cold, or low voltage. 	Warning: HOT BATTERY WAITING TO CHARGE or COLD BATTERY WAITING TO CHARGE or VERY LOW BATTERY WAITING TO CHARGE	Flashing Amber 

Table 14: Preparing New (Never Calibrated) IMPRES 2 or IMPRES Batteries for Long-Term Storage - Calibration Required



Status	Charger Display	LED Indicator
Charger Powers On	IMPRES 2 CHARGER	Green for approximately one second 
Battery Detected	IMPRES 2 BATTERY or IMPRES BATTERY	Battery requires Calibration, but Calibration is disabled by Long-Term Storage: Alternating Amber/ Green for four seconds 

Table 14: Preparing New (Never Calibrated) IMPRES 2 or IMPRES Batteries for Long-Term Storage - Calibration Required (Cont.)











Status	Charger Display	LED Indicator
Battery Discharging (Discharging to find 0% Rated Capacity)	STORAGE DISCHRG	Steady Amber 
Rapid Charging (Charging to selection)	STORAGE CHARGE xx% Rated Cap	Steady Red 
Nearly Charged (Charging to selection)	STORE TRKL CHRG xx% Rated Cap	Flashing Green 
<ul style="list-style-type: none"> Charge Complete Ready to Store 	LONGTERM STORAGE xx% Rated Cap	Battery does not require Calibration: Steady Green  Battery requires Calibration: Alternating Amber/ Green 
Fault <ul style="list-style-type: none"> Battery Faulted No discharge current Capacity too low to complete charge 	Warning: NOT CHARGEABLE REMOVE& REINSERT or CANNOT DISCHARGE FOR LT STORAGE or STORE INCOMPLETE Low Capacity:yy%	Flashing Red 
Standby <ul style="list-style-type: none"> Battery is waiting to rapid charge. Battery may be too hot, too cold, or low voltage. 	Warning: HOT BATTERY WAITING TO CHRG or COLD BATTERY WAITING TO CHRG or VERY LOW BATTERY WAITING TO CHRG	Flashing Amber 

Table 15: Preparing Other Motorola Solutions, Non-Motorola Solutions, or Unknown Batteries for Long-Term Storage

Status	Charger Display	LED Indicator
Charger Powers On	IMPRES 2 CHARGER	Green for approximately one second 
Battery Detected • Other Motorola Solutions battery • Unknown battery	WRONG BATT TYPE CANNOT LT STORAGE	Flashing Red 
Fault (Battery Faulted)	Warning: NOT CHARGEABLE REMOVE & REINSERT	Flashing Red 
Standby • Battery is waiting to rapid charge. • Battery may be too hot, too cold, or low voltage.	Warning: HOT BATTERY WAITING TO CHARGE or COLD BATTERY WAITING TO CHARGE or VERY LOW BATTERY WAITING TO CHARGE	Flashing Amber 

Lithium-Ion Battery Preparation for Shipment

You can prepare IMPRES 2, IMPRES, or other authentic Motorola Solutions Lithium-Ion batteries for shipment by air cargo. Selection of Lithium Shipment supersedes Calibration/Reconditioning.

Table 16: Preparing IMPRES 2 or IMPRES Lithium-Ion Batteries for Shipment - Calibration Not Required



Status	Charger Display	LED Indicator
Charger Powers On	IMPRES 2 CHARGER	Green for approximately one second 
Battery Detected	IMPRES 2 BATTERY or IMPRES BATTERY	Battery requires Discharge: Steady Amber  Battery requires Charge: Steady Red 

Table 16: Preparing IMPRES 2 or IMPRES Lithium-Ion Batteries for Shipment - Calibration Not Required (Cont.)







Status	Charger Display	LED Indicator
Battery Discharging (Discharging to selection)	SHIP LI DISCHRG xx% Rated Cap	Steady Amber 
Rapid Charging (Charging to selection)	SHIP LI CHARGE xx% Rated Cap	Steady Red 
<ul style="list-style-type: none"> Discharge or Charge Complete Ready to Ship 	SHIP LI DISCHRG or LI READY TO SHIP xx% Rated Cap	Battery does not require Calibration: Steady Green  Battery requires Calibration, but Calibration is disabled in charger: Alternating Amber/ Green 
Fault <ul style="list-style-type: none"> Battery Faulted No discharge current Capacity too low to complete charge 	Warning: NOT CHARGEABLE REMOVE& REINSERT or CANNOT DISCHARGE FOR LI SHIPMENT or SHIP INCOMPLETE Low Capacity:yy%	Flashing Red 
Standby <ul style="list-style-type: none"> Battery is waiting to discharge or charge. Battery may be too hot, too cold, or low voltage. 	Warning: HOT BATTERY WAITING TO CHRGE or COLD BATTERY WAITING TO CHRGE or VERY LOW BATTERY WAITING TO CHRGE	Flashing Amber 

Table 17: Preparing New (Never Calibrated) IMPRES 2 or IMPRES Lithium-Ion Batteries for Shipment - Calibration Required







Status	Charger Display	LED Indicator
Charger Powers On	IMPRES 2 CHARGER	Green for approximately one second 
Battery Detected	IMPRES 2 BATTERY or IMPRES BATTERY	Battery requires Calibration, but Calibration is disabled by Ship Lithium: Alternating Amber/ Green for four seconds 
Battery Discharging (Discharging to find 0% Rated Capacity)	SHIP LI DISCHRG	Steady Amber 
Rapid Charging (Charging to selection)	SHIP LI CHARGE xx% Rated Cap	Steady Red 
<ul style="list-style-type: none"> Charge Complete Ready to Ship 	LI READY TO SHIP xx% Rated Cap	Battery does not require Calibration: Steady Green  Battery requires Calibration: Alternating Amber/ Green 
Fault <ul style="list-style-type: none"> Battery Faulted No discharge current Capacity too low to complete charge 	Warning: NOT CHARGEABLE REMOVE& REINSERT or CANNOT DISCHARGE FOR LI SHIPMENT or SHIP INCOMPLETE Low Capacity:yy%	Flashing Red 

Table 17: Preparing New (Never Calibrated) IMPRES 2 or IMPRES Lithium-Ion Batteries for Shipment - Calibration Required (Cont.)

Status	Charger Display	LED Indicator
Standby <ul style="list-style-type: none"> Battery is waiting to rapid charge. Battery may be too hot, too cold, or low voltage. 	Warning: HOT BATTERY WAITING TO CHARGE or COLD BATTERY WAITING TO CHARGE or VERY LOW BATTERY WAITING TO CHARGE	Flashing Amber 

Table 18: Preparing Other Motorola Solutions Lithium-Ion Batteries for Shipment











Status	Charger Display	LED Indicator
Charger Powers On	IMPRES 2 CHARGER	Green for approximately one second 
Battery Insertion	MOTOROLA SOLUTIONS BATTERY	Steady Amber 
Battery Discharging	SHIP LI DISCHRG	Steady Amber 
Rapid Charging	SHIP LI CHARGE xx% Rated Cap	Steady Red 
<ul style="list-style-type: none"> Charge Complete Ready to Ship 	LI READY TO SHIP xx% Rated Cap	Steady Green 
Fault	Warning: NOT CHARGEABLE REMOVE& REINSERT	Flashing Red 
Standby <ul style="list-style-type: none"> Battery is waiting to rapid charge. Battery may be too hot, too cold, or low voltage. 	Warning: HOT BATTERY WAITING TO CHARGE or COLD BATTERY WAITING TO CHARGE or VERY LOW BATTERY WAITING TO CHARGE	Flashing Amber 

Table 19: Preparing Other Motorola Solutions Nickel Batteries or Unknown Batteries for Shipment

Status	Charger Display	LED Indicator
Charger Powers On	IMPRES 2 CHARGER	Green for approximately one second 
Battery Detected <ul style="list-style-type: none"> Other Motorola Solutions battery Unknown battery 	WRONG BATT TYPE CANNOT SHIP LI	Flashing Red 
Fault (Battery Faulted)	Warning: NOT CHARGEABLE REMOVE & REINSERT	Flashing Red 
Standby <ul style="list-style-type: none"> Battery is waiting to rapid charge. Battery may be too hot, too cold, or low voltage. 	Warning: HOT BATTERY WAITING TO CHARGE or COLD BATTERY WAITING TO CHARGE or VERY LOW BATTERY WAITING TO CHARGE	Flashing Amber 

Charger Setup



Empty all charger pockets before entering charger setup.

The charger Keypad is located beside the Display associated with Pocket 1.



Figure 5: Charger Display and Keypad

Main Menu

- To enter Charger Setup Menu, simultaneously press and hold the Left Arrow and Right Arrow buttons for at least three seconds. The hold time is adjustable. The display shows:

Press OK to entr
SETUP MENU

- Pressing OK prompts display of available Charger Setup Menu.

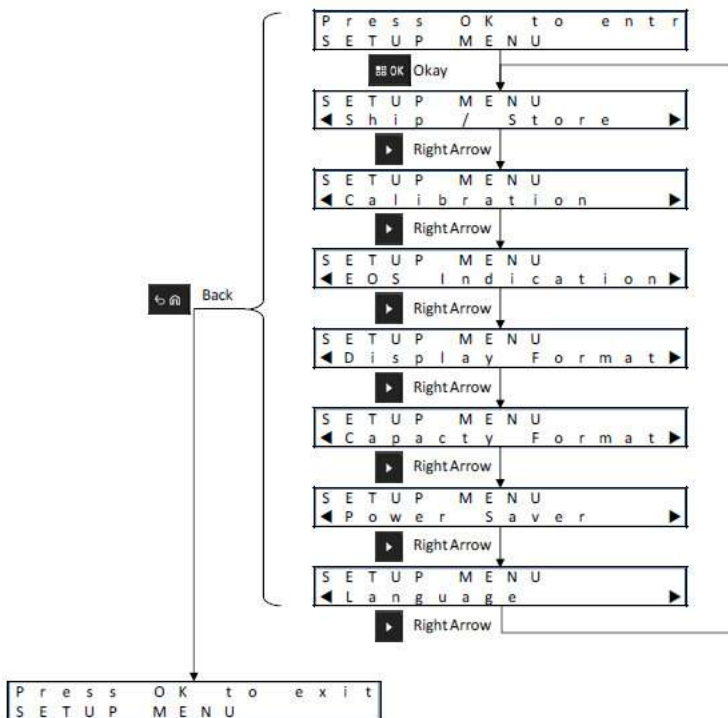

Figure 6: Charger Setup Menu

- Press the Right Arrow to sequence through the Charger Setup Menu selections as represented.
- Press the Left Arrow to sequence through the Charger Setup Menu selections in reverse order.

- Press OK to enter the Charger Setup Menu for the selection currently displayed. Within the Setup Menu:
- Press Back to Exit from Charger Setup Menu. Press OK to confirm exit.

If no Keypad button is pressed for 10 minutes, then the charger exits Charger Setup and returns to normal message displays.

Charger Setup Menu Selection

Within each Setup Menu selection:

- Press the Right Arrow to sequence through the Options as represented.
- Press the Left Arrow to sequence through the Options in reverse order.
- Check mark identifies the current Option selection.
- Pressing OK either removes the Check mark from a selected Option or adds the Check mark to select the displayed Option.
- Press Back to exit from the Setup Menu. Press OK to confirm exit.

Charger Setup selections are stored in non-volatile memory. Selections are not affected by cycling charger power.

Ship/Storage Menu

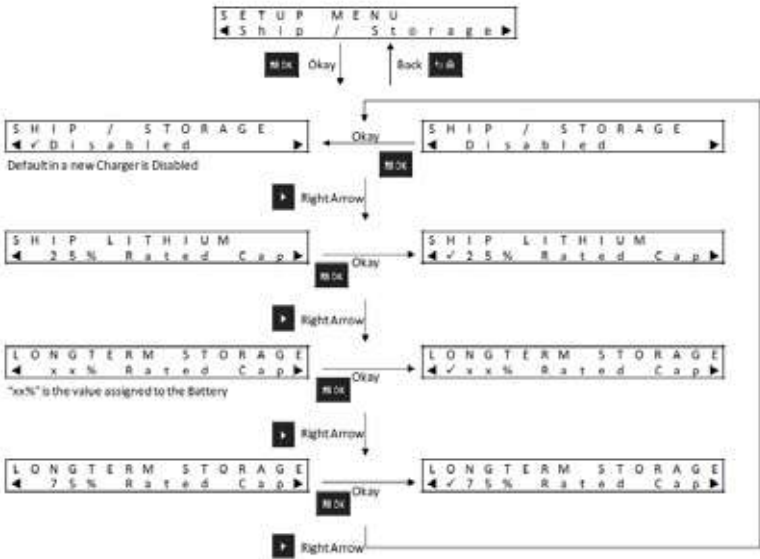

Figure 7: Ship/Storage Menu

There are four Ship/Storage options:

1. Disabled
2. Ship Lithium-Ion
3. Long-Term Storage
4. Long-Term Storage at 75% of Rated Capacity

Ship Lithium-Ion, Long-Term Storage, and Long-Term Storage 75% selections supersede the Calibration setting.

Ship Lithium

Ship Lithium sets the State of Charge (SoC) of a Motorola Solutions Lithium-Ion battery to a low value (typically, approximately 25% of Rated Capacity) permitted for bulk air cargo shipment. This feature

applies only to IMPRES 2, IMPRES, or other authentic Motorola Solutions Lithium-Ion batteries.

The charger may fully-discharge some Motorola Solutions batteries before charging to the Ship Lithium limit. Such batteries include IMPRES 2 or IMPRES batteries that were never calibrated or need a new calibration. Also included are authentic Motorola Solutions Lithium-Ion batteries that are not IMPRES 2 or IMPRES.

Ship Lithium does not apply to Nickel batteries or Unknown batteries. These batteries will be Faulted.

Long-Term Storage

Long-Term Storage sets the IMPRES 2 or IMPRES battery to a SoC suitable when storing the battery for a long period of time. Usually, the preferred SoC for storage is significantly less than fully charged, such as 50%. Long-Term Storage at 75% Rated Capacity is available for scenarios requiring the stored battery to be at a higher SoC, minimizing full-charge time if the battery must be quickly fielded.

The charger may fully-discharge some Motorola Solutions batteries before charging to the Long-Term Storage limit. Such batteries include IMPRES 2 or IMPRES batteries that were never previously calibrated or need a new calibration.

Long-Term Storage and Long-Term Storage 75% do not apply to Unknown batteries or Motorola Solutions batteries that are not IMPRES 2 or IMPRES batteries. These batteries will be Faulted.

Calibration Menu

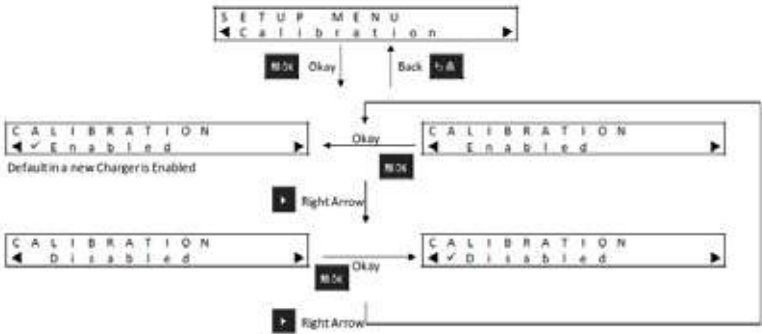

Figure 8: Calibration Menu

The Calibration setup selections enables or disables the Discharge phase of Calibration/Reconditioning. The Discharge phase precedes the full charge required for successful Calibration/Reconditioning. This feature is useful when the charger is deployed to a location requiring the battery to be at a charged state of readiness as quickly as possible. In these situations, waiting a few extra hours for full battery discharge may be inconvenient.

If an IMPRES 2 or IMPRES battery is due for Calibration, this battery is discharged when inserted into the charger, and the charger has Calibration disabled, the charger will take advantage of this situation. Completion of battery charge will automatically complete IMPRES battery Calibration.

End-of-Service Life Indication Menu

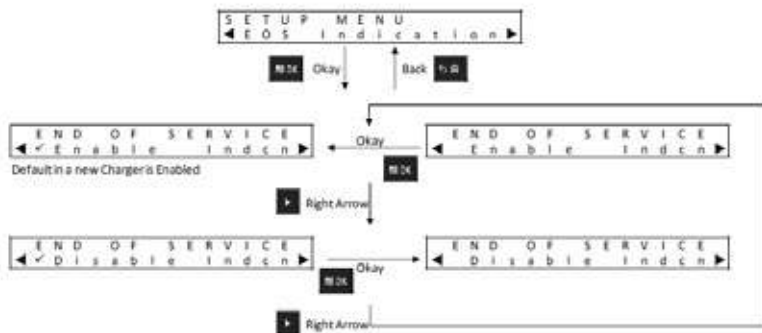

Figure 9: End-of-Service Life Indication Menu

Even though the IMPRES 2 or IMPRES battery may be nearing its End of Service, the battery capacity may be more than adequate given how it is used. As a result, it may be desirable to disable the End of Service Life Indication (alternating Red/Green) that the charger indicates at the end of battery charge.

Display Format Menu

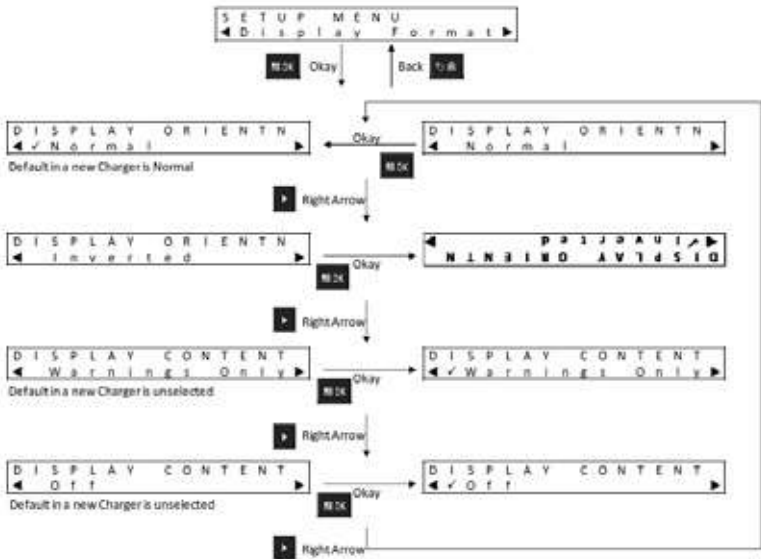

Figure 10: Display Format Menu

There are four Display Format options:

1. Normal orientation (charger sitting on a desktop).
2. Inverted orientation (charger hanging on a wall).
3. Warning messages only. Other messages are not displayed. This applies to Normal and Inverted orientations. Warning messages are identified in Table 7 through Table 19.
4. Display off.

Capacity Format Menu

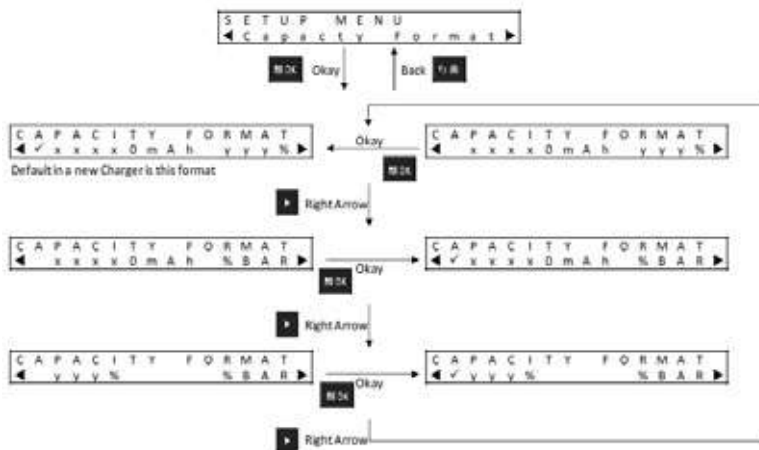

Figure 11: Capacity Format Menu

Battery Capacity display options include:

Table 20: Battery Capacity Display Options

Representation	Description
x x x 0 m A h	Present Charge (State of Charge) in milliamp-hours.
y y y %	Present Charge relative to the Potential Capacity (when fully charged), in percent. The maximum value is 100%.
%BAR	The equivalent of y y y % represented in an eight-segment bar.

Power Saver Menu

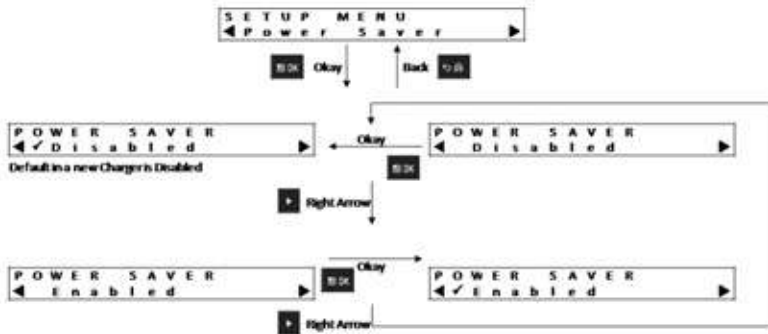

Figure 12: Power Saver Menu

To meet certain government low standby power limits, Power Saver mode enables the charger to turn off Pocket 2 through Pocket 6 when there is no activity in those pockets for a period of time. Examples of activity include the following:

- Radio or battery charging
- Battery Calibration/Reconditioning
- Lithium-Ion Battery preparation for shipment
- Battery preparation for Long-Term Storage
- Charger Setup Mode
- Charger Analysis Mode
- Fault
- Recommending Calibration/Reconditioning

Pocket 1 remains on, but may be sleeping. To turn on Pocket 2 through Pocket 6, press any Keypad button. Until Pocket 2 through Pocket 6 are turned on, they cannot respond to radio or battery insertion, or removal.

Entry Time Menu

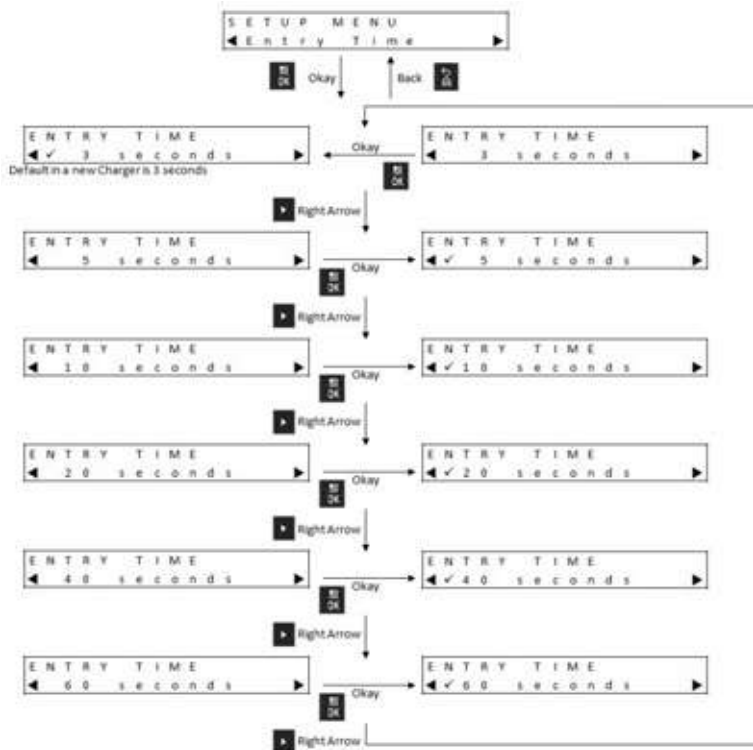

Figure 13: Entry Time Menu

Entry Time is the hold time required to simultaneously press the Left Arrow and Right Arrow buttons to enter Charger Setup mode or Charger Analyzer mode.

Language Menu

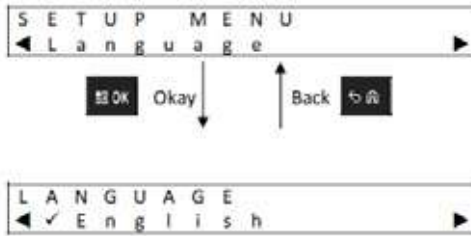

Figure 14: Language Menu

The charger display supports North American English only.

Analyzer Mode

You can enter Analyzer Mode by firmly pressing the OK button from more than 3 seconds (the hold time is adjustable.) The Analyzer Mode features described are associated with charger software version 1.05.

Pressing OK displays data available from the battery or charging pocket on the display adjacent to the Pocket, followed by Charger software version.

- Press the Right Arrow to sequence through the data as represented.
- Press the Left Arrow to sequence through the data in reverse order.
- Press Back to exit from Analyzer Mode. Press OK to confirm exit.

If no Keypad button is pressed for 10 minutes, then the charger exits Analyzer Mode and returns to normal message displays.

While in Analyzer Mode, if the battery is removed and replaced by another battery, the last parameter displayed for the first battery will be the first parameter displayed for the second battery. For example, while Battery IMPRES Cycles is being displayed, the IMPRES 2 or IMPRES battery is removed from Pocket 1 and a different IMPRES 2 or IMPRES battery is inserted into Pocket 1. The first parameter display for the second battery will be Battery IMPRES Cycles.

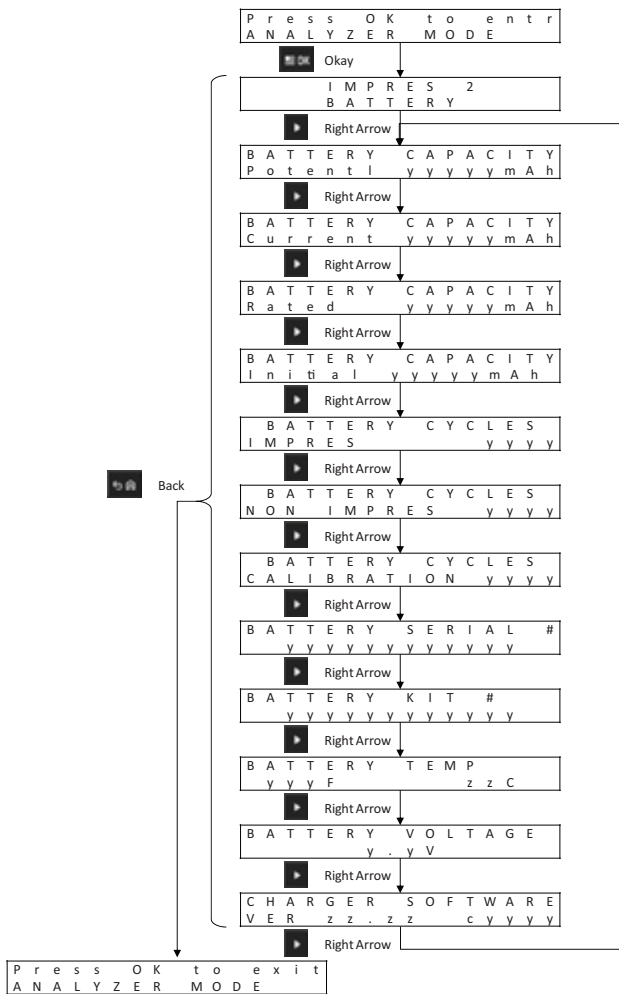

Figure 15: IMPRES 2 Battery Menu

IMPRES Battery

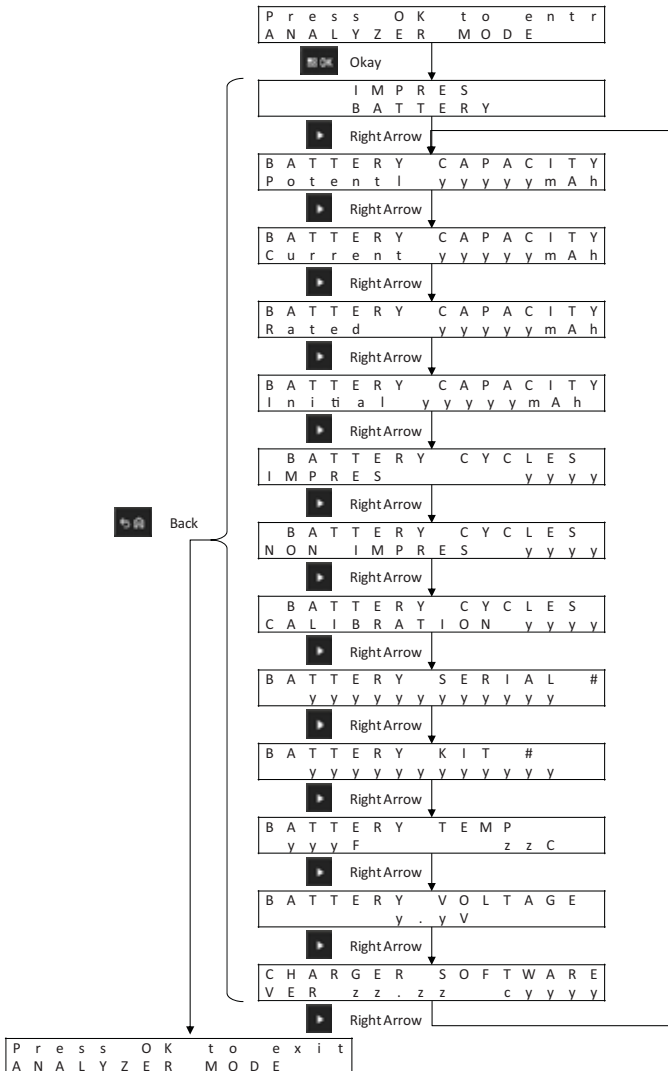

Figure 16: IMPRES Battery Menu

Other Motorola Solutions Battery

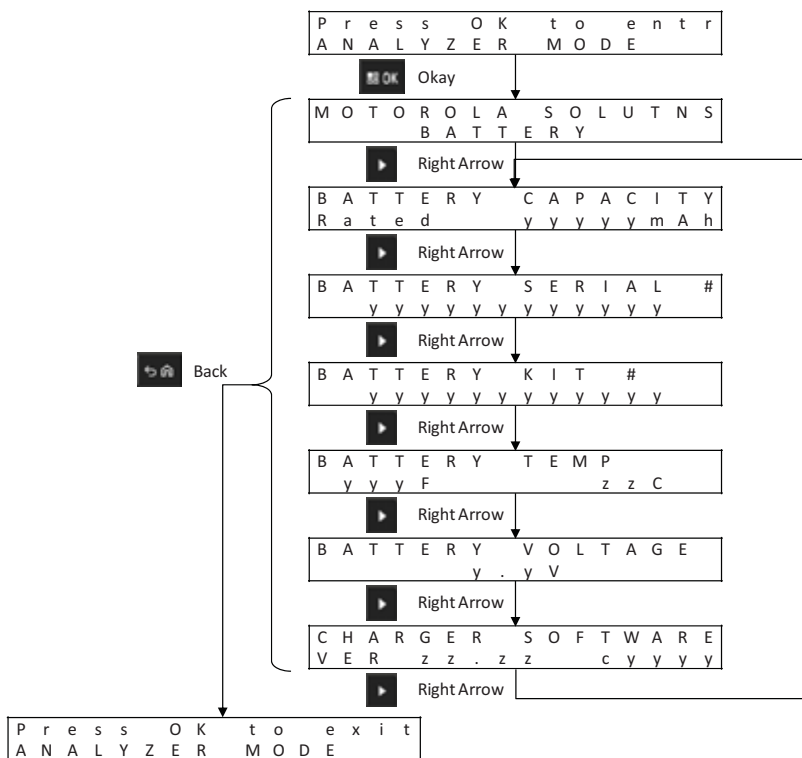

Figure 17: Other Motorola Solutions Battery Menu

Unknown Battery

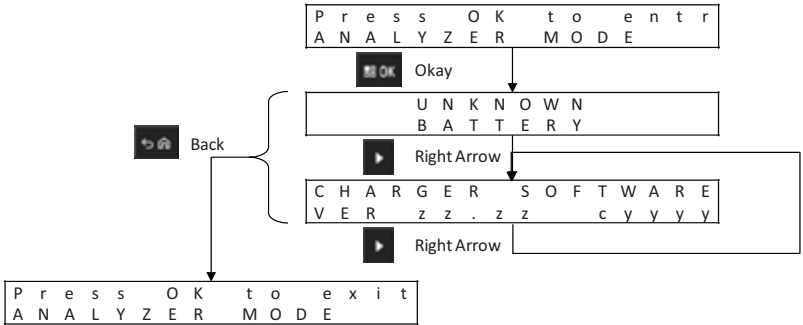

Figure 18: Unknown Battery Menu

Empty Pocket

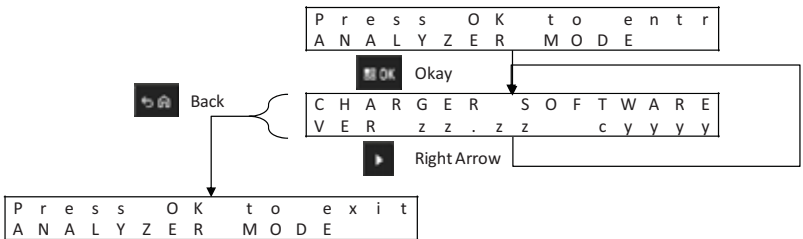

Figure 19: Empty Pocket Menu

Charger Reprogramming

Charger reprogramming requires the Communications Interface connected to a computer using a standard USB cable. Using the IMPRES Battery Fleet Management System to initiate charger reprogramming, the following messages are displayed by the charger.

Table 21: Charger Reprogramming Display Options

Charger Display	Description
REPROGRAMMING REMOVE BATTERIES	Remove batteries from the charger pockets before reprogramming.
REPROGRAMMING WAITING FOR DATA	All charger pockets are empty.
REPROGRAMMING Progress yyj%	Reprogramming data is downloading. For chargers with a display associated with each pocket, the percentage value is the percentage of data successfully downloaded into the pocket associated with the display. For chargers that have only one display (Pocket 1), the percentage value is the percentage of data successfully downloaded into all six pockets.
REPROGRAMMING POCKET#xx FAILED	Reprogramming failed in the identified pocket. The identified charger pocket will start normal operations using the previous software.
IMPRES 2 CHARGER	Reprogramming data download is complete. The charging is completing the Reprogramming process.
REPROGRAMMING COMPLETE	The Reprogramming process completed successfully. The charger will start normal operations using the newly downloaded software.

Charger Troubleshooting

Table 22: Troubleshooting

Problem	What to do...
Charger powers ON, but the LED does not flash Green.	Make sure that the power cord is securely plugged into the charger and an appropriate AC power outlet, and that there is power to the outlet. Inspect fuses and replace as necessary.
Battery inserted, but LED remains OFF and display does not identify battery.	If battery is inserted into any Pocket (except Pocket 1), and if Power Saver is Enabled, then press the Menu button. See Fault.

Table 22: Troubleshooting (Cont.)

Problem	What to do...
Fault	<p>Check if the radio or the stand-alone battery is inserted correctly. Check for contact contamination or corrosion:</p> <ul style="list-style-type: none"> • Remove the radio or stand-alone battery from the charger. • Verify that the battery is an authorized Motorola Solutions battery listed in Table 5. Other batteries may not charge. • Inspect the charging contacts on the battery for contamination or corrosion. Clean the charging contacts using a dry cloth. • Inspect the charging contacts in the charger pocket for contamination or corrosion. If contamination or corrosion are found, remove power from the charger and clean the charging contacts using a dry cloth. <p>Try replacing the battery. If the fault no longer exists, then take the faulted battery out of service.</p> <p>If the fault persists with the replacement battery, take the charger out of service.</p>
<ul style="list-style-type: none"> • Charger display shows the following when the battery is thought to be an authorized Motorola Solutions battery: UNKNOWN BATTERY or • Charger display shows the following when preparing an authorized Motorola Solutions Lithium-ion battery for shipment: CANNOT DISCHARGE FOR LI SHIPMENT 	<p>Remove the radio or stand-alone battery from the charger. Verify that the battery is an authorized Motorola Solutions battery listed in Table 5. Other batteries may not charge. If the battery is an authorized Motorola Solutions battery, then:</p> <ul style="list-style-type: none"> • Inspect the charging contacts on the battery for contamination or corrosion. If contamination or corrosion are found, remove power from the charger, and clean the charging contacts using a dry cloth. • Reinsert the authorized Motorola Solutions radio or stand-alone battery.

IMPRES Battery Fleet Management System

IMPRES Battery Fleet Management software automatically collects critical data from IMPRES or IMPRES 2 batteries that are inserted into an IMPRES charger. The critical data include battery age, capacity, charge and Calibration/Recondition history, date when manufactured, and date when put into service. IMPRES Battery Fleet Management software analyzes battery data, communicates battery health, and recommends when to replace the battery. As a result, it can quickly and efficiently determine whether or not to redeploy the battery to a less demanding user, when to purchase a new replacement battery, or that a battery is missing.

IMPRES Battery Fleet Management delivers battery-critical information:

- When batteries are below an acceptable capacity.
- Helps to ensure users have enough capacity for a full work shift.
- Identifies low-capacity batteries so they can be removed from service.
- Eliminates unexpected downtime and work interruptions.
- Avoids the expense of throwing batteries away prematurely.
- Confirms chargers are optimally distributed and used.

IMPRES Battery Fleet Management consists of three major components:

1. The application software.
2. A software license key.
3. A USB cable to connect the IMPRES 2 charger to a computer.

The IMPRES Battery Fleet Management application software is scalable from a single site to a multi-site networked system. The system can be networked to support up to 25,000 batteries in the same location or over geographically dispersed areas.

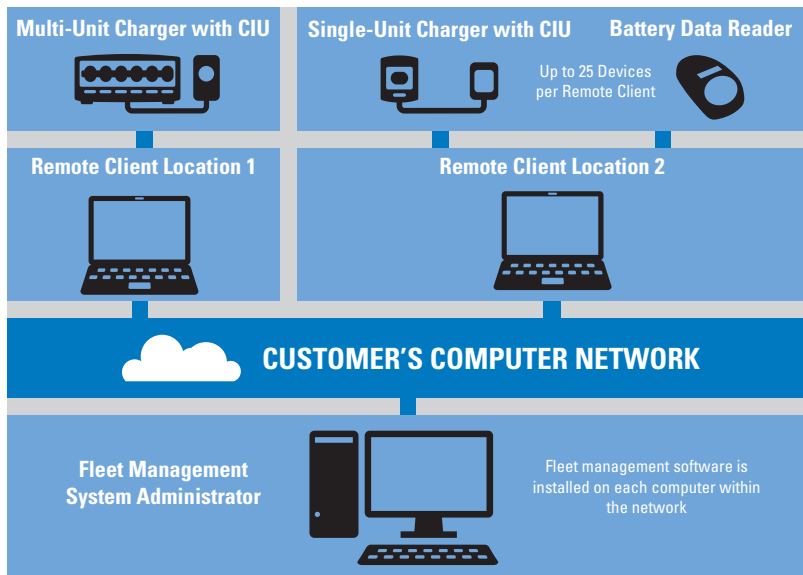

Figure 20: IMPRES Battery Management via Network Chargers

Each IMPRES Battery Fleet Management System software license supports:

- One system Administrator Server.
- 19 Remote Clients.
- 25 IMPRES Chargers or IMPRES Battery Readers per client.
- 25,000 IMPRES Batteries (the total number of batteries for the entire system cannot exceed 25,000).

Use existing reports to customize new ones to see the most relevant information for your organization. Data is stored in your database and can be exported to an Excel file or printed. IMPRES Battery Fleet Management software records and organizes a variety of data so you can:

- See a status snapshot of your entire battery fleet.
- Evaluate whether batteries are meeting your performance criteria.
- Determine when batteries are nearing their end of life.
- Determine when to buy new batteries.

- Obtain lost battery report.
- Optimize charger utilization.
- Monitor all devices in the system.

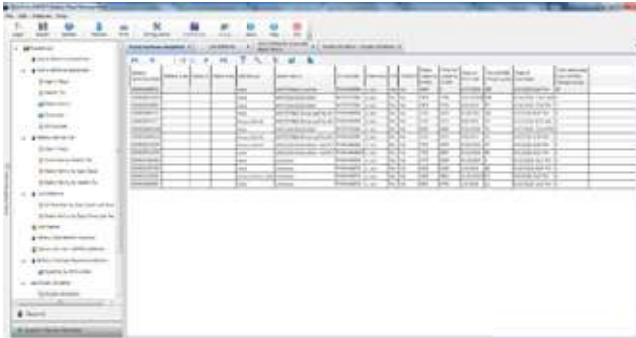

Figure 21: Active Battery Report

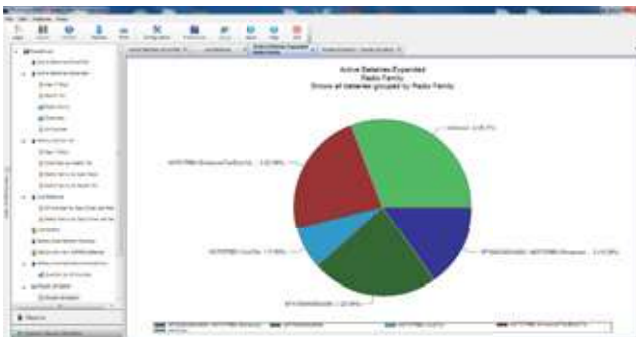

Figure 22: Batteries in Use by Radio Family



Figure 23: Lost Battery by Location



Figure 24: Charger Pocket Utilization

Charging Pocket Installation

Removing Charging Pocket from Multi-Unit Charger

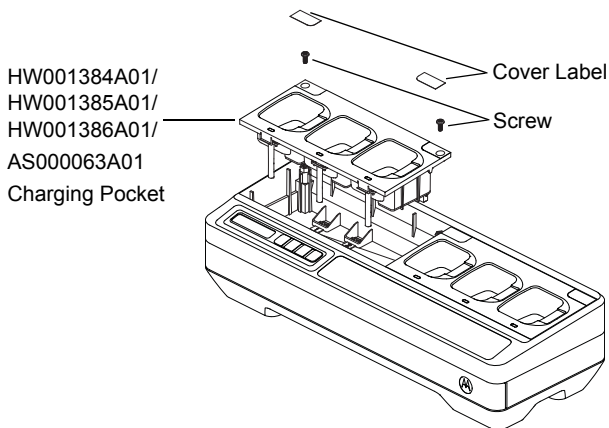

Figure 25: Installing and Removing HW001384A01/HW001385A01/
HW001386A01/AS000063A01 Charging Pocket

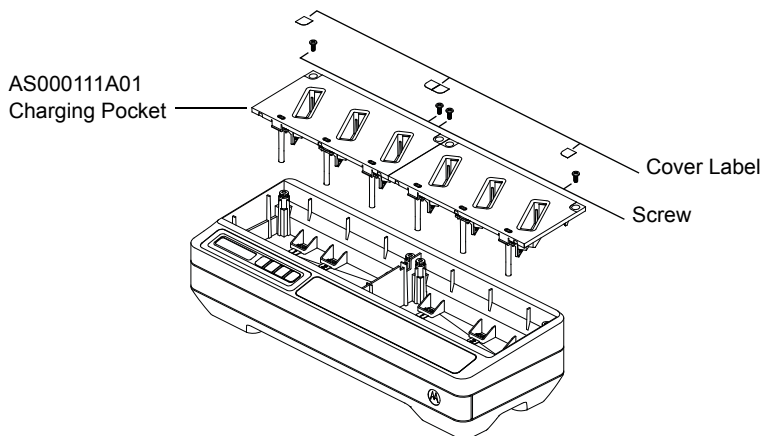

Figure 26: Installing and Removing AS000111A01 Charging Pocket

1. Remove the Cover Label on the Charging Pocket.

2. Remove the screw that secures the Charging Pocket to the base.
3. Lift the Charging Pocket a few inches away from the base.
4. Remove the Pocket Harness by pulling straight up on the connector (Refer to Figure 25 and Figure 26).

Securing Charging Pocket to Multi-Unit Charger

HW001384A01/HW0001385A01/
AS000063A01

HW001386A01

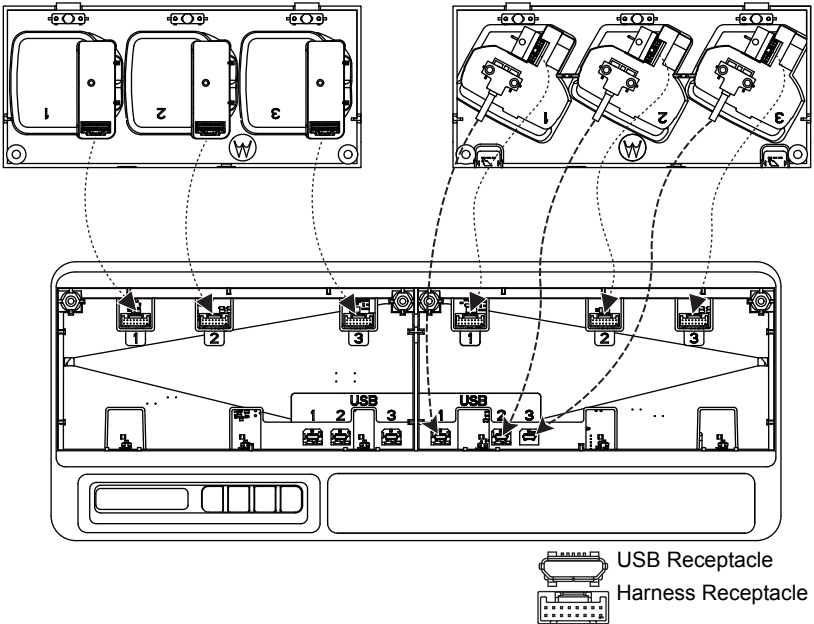

Figure 27: Securing HW001384A01/HW001385A01/HW001386A01/
AS000063A01 Charging Pockets to Multi-Unit Charger Base

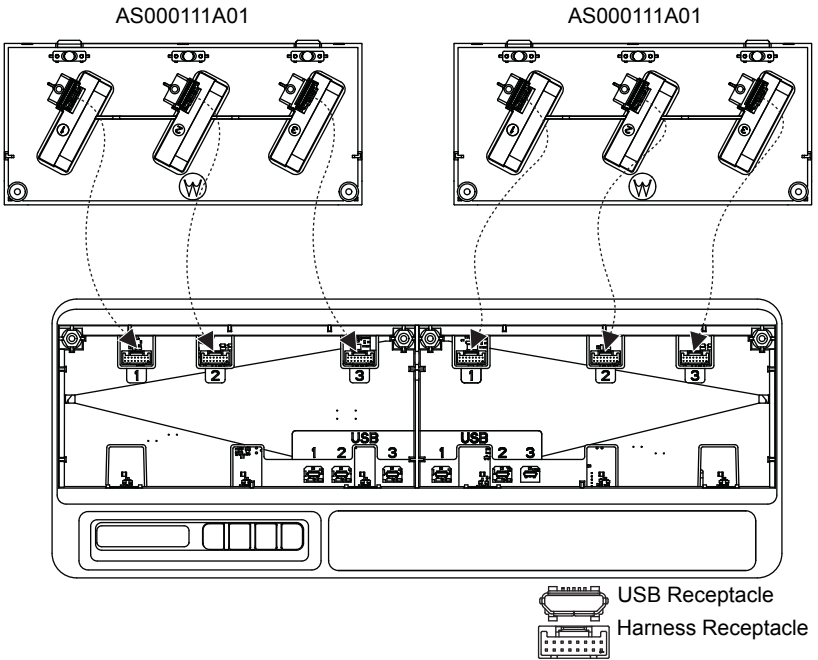

Figure 28: Securing AS000111A01 Charging Pockets to Multi-Unit Charger Base

1. Plug in the USB connector and harness connector to the receptacles on the base.

Note: USB or harness connector may not be available on some of the Charger Pocket. Plug in the available connectors to the base.

2. Slot in the Charging Pocket to the base and ensure the Charging Pocket is flushed into the Multi-Unit Charger. Affix the Charging Pocket screw.

Programming a Radio with iTM Proxy (PMPN4286_)

Note: Contact your local dealer to order the programming cable (Part Number: CB000521A01).

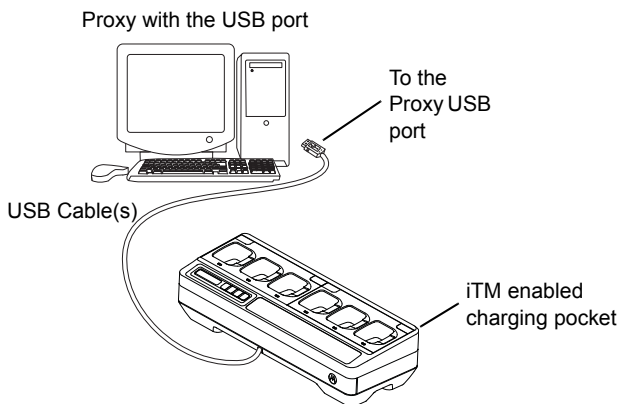

Figure 29: Connecting Radios to iTM Proxy Using Multi-Unit Charger

1. Connect the programming cable from the USB hub of the Multi-Unit Charger to the computer.

Optional Equipment

A wall mount bracket (Part Number: BR000271A01) is available for the Multi-Unit Charger. Contact your local dealer to order this item. Installation is shown below.



WARNING

- This wall mount bracket should be installed by a trained and experienced technician. Having the product installed by a non-specialized technician is very dangerous, and can cause damage or injury.
- Do not install the product where the weight cannot be supported. If the strength of the location where the wall mount is installed is not strong enough, it can fall off and cause an injury.
- Do not install on a structure that is prone to vibration, movement, or chance of impact.

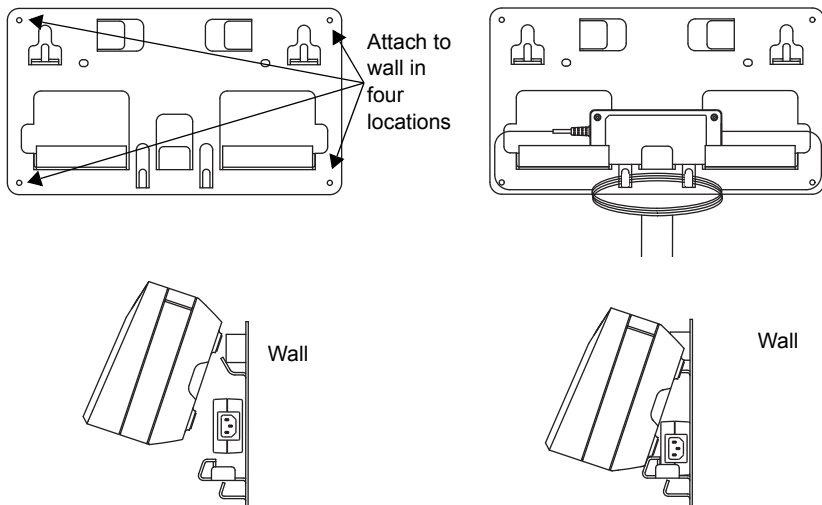

Figure 30: Mounting Multi-Unit Charger to Wall Bracket

Mounting Multi-Unit Charger to Wall Bracket

1. Position the wall mount bracket in the desired position, and mark the location of the mounting holes on the wall surface.



Caution

Ensure the area behind the mounting surface is always free of electrical wires, cables, and pipes before cutting, drilling, or installing the mounting screws.

2. Mount bracket to wall using the appropriate mounting hardware required for the type of wall material fixture it is being mounted to. Drill based on the marked mounting holes on the wall surfaces.
3. Secure the wall bracket in position by installing mounting hardware over the mounting holes on the wall bracket tightly.

Note: It is recommended to use 10-16x1-1/2" tapping screw and washer (not included) on wood stud and solid-flat concrete/brick wall.

4. Hang the Multi-Unit Charger on wall bracket as show in Figure 30.